



Post Office Box 97  
Benton Harbor, MI 49023-0097  
Ph: 616-926-6171  
Fax: 616-925-8288

70-6100/F2-205  
AK811 (Rev. G)



# INSTALLATION AND OPERATING INSTRUCTIONS FOR GAST HAZARDOUS DUTY REGENAIR BLOWERS

This instruction applies to the following models ONLY: R3105N-50, R4110N-50, R4310P-50, R4P115N-50, R5125Q-50, R5325R-50, R6130Q-50, R6P155Q-50, R6340R-50, R6P355R-50 and R7100R-50.

## AUTHORIZED SERVICE FACILITIES

Gast Manufacturing Inc.  
2550 Meadowbrook Road  
Benton Harbor, MI 49022  
TEL: 616-926-6171  
FAX: 616-925-8288  
[www.gastmfg.com](http://www.gastmfg.com)

Gast Manufacturing Inc.  
505 Washington Avenue  
Carlstadt, NJ 07072  
TEL: 201-933-8484  
FAX: 201-933-5545  
[www.gastmfg.com](http://www.gastmfg.com)

Brenner Fiedler & Assoc  
13824 Bentley Place  
Cerritos, CA 90701  
TEL: 800-843-5558  
TEL: 310-404-2721  
FAX: 310-404-7975  
[www.brenner-fiedler.com](http://www.brenner-fiedler.com)

Gast Manufacturing Co., Ltd.  
Beech House  
Knaves Beech Business Centre  
Loudwater, High Wycombe  
Bucks, England HP10 9SD  
TEL: 011-44 1628 532600  
FAX: 011-44 1628 532470  
<http://www.gastltd.com>

Wainbee Limited  
215 boul Brunswick  
Pointe Claire, Quebec  
Canada H9R 4R7  
TEL: 514-697-8810  
FAX: 514-697-3070

Wainbee Limited  
5789 Coopers Avenue  
Mississauga, Ontario  
Canada L4Z 3S6  
TEL: 905/568-1700  
FAX: 905/568-0083  
<http://www.wainbee.ca>



Japan Machinery Co., Ltd  
Central PO Box 1451  
Tokyo, 100-91 Japan  
TEL: 813 3573 5421  
FAX: 813 3571 7865  
or: 81-3-3571-7896

*NOTE: General correspondence should be sent to—*  
Gast Mfg. Inc./A Unit of IDEX Corporation  
P O Box 97  
Benton Harbor, MI 49023-0097

## SAFETY

This is the safety alert symbol: . When you see this symbol, be aware that personal injury or property damage is possible. The hazard is explained in the text following the symbol.

The following is an explanation of the three different types of hazards:

-  **DANGER** Severe personal injury or death will occur if hazard is ignored.
-  **WARNING** Severe personal injury or death can occur if hazard is ignored.
-  **CAUTION** Minor injury or property damage can occur if hazard is ignored.

Read the information carefully before operating.

---

## GENERAL INFORMATION

This instruction applies to the following models ONLY: R3105N-50, R4110N-50, R4310P-50, R4P115N-50, R5125Q-50, R5325R-50, R6130Q-50, R6P155Q-50, R6340R-50, R6P355R-50 and R7100R-50. These blowers are intended for use in Soil Vapor Extraction Systems. The blowers are sealed at the factory for very low leakage. They are powered with a U.L. listed electric motor Class 1 Div. 1 Group D for Hazardous Duty locations. Ambient temperature for normal full load operation should not exceed 40°C (105°F). For higher ambient operation, contact the factory.

Gast Manufacturing Incorporated may offer general application guidance; however, suitability of the particular blower and/or accessories is ultimately the responsibility of the user, not the manufacturer of the blower.

---

## INSTALLATION

 **DANGER** Models R5325R-50, R6130Q-50, R6340R-50, R5125Q-50, R6P155Q-50, R6P355R-50 and R7100R-50 use Pilot Duty Thermal Overload Protection. Connecting this protection to the proper control circuitry is mandated by UL674 and NEC501. Failure to do so could/may result in an EXPLOSION. See pages 3 and 4 for recommended wiring schematic for these models.

 **WARNING** Electric shock can result from bad wiring. A qualified person must install all wiring, conforming to all required safety codes. Grounding is necessary.

 **WARNING** This blower is intended for use on soil vapor extraction equipment. Any other use must be approved in writing by Gast Manufacturing, Inc.

Install this blower in any mounting position. Do not block the flow of cooling air over the blower and motor.

## PLUMBING

Use the threaded pipe ports for connection only. They will not support the plumbing. Be sure to use the same or larger size pipe to prevent air flow restriction and overheating of the blower. When installing fittings, be sure to use pipe thread sealant. This protects the threads in the blower housing and prevents leakage. Dirt and chips are often found in new plumbing. Do not allow them to enter the blower.

## NOISE

Mount the unit on a solid surface that will not increase the sound. This will reduce noise and vibration. We suggest the use of shock mounts or vibration isolation material for mounting.

## ROTATION

The Gast Regenair Blower should only rotate clockwise as viewed from the electric motor side. The casting has an arrow showing the correct direction. Confirm the proper rotation by checking air flow at the IN and OUT ports. If needed reverse rotation of three phase motors by changing the position of any two of the power line wires.

---

## OPERATION

 **WARNING** Solid or liquid material exiting the blower or piping can cause eye damage or skin cuts. Keep away from air stream.

 **WARNING** Gast Manufacturing, Incorporated will not knowingly specify, design or build any blower for installation in a hazardous, combustible or explosive location without a motor conforming to the proper NEMA or U.L. standards.

Blowers with standard TEFC motors should never be utilized for soil vapor extraction applications or where local, state and / or Federal codes specify the use of explosion-proof motors (as defined by the National Electric Code, Articles 100,500 c1990).

 **CAUTION** Attach blower to solid surface before starting to prevent injury or damage from unit movement.

Air containing solid particles or liquid must pass through a filter before entering the blower. Blowers must have filters, other accessories and all piping attached before starting. Any foreign material passing through the blower may cause internal damage to the blower.

**⚠ CAUTION** Outlet piping can burn skin. Guard or limit access. Mark “**CAUTION Hot Surface. Can Cause Burns.**”

Air temperature increases when passing through the blower. When run at duties above 50 in. H<sub>2</sub>O, metal pipe may be required for hot exhaust air. The blower must not be operated above the limits for continuous duty. Only models R3105N-50, R4110N-50 and R4310P-50 can be operated continuously with no air flowing through the blower. Other units can only be run at the rating shown on the model number label. Do not close off inlet (for vacuum) to reduce extra air flow. This will cause added heat and motor load. Blower exhaust air in excess of 230°F indicates operation in excess of rating which can cause the blower to fail.

**ACCESSORIES**

Gast pressure gauge AJ496 and vacuum gauges AJ497 or AE134 show blower duty. The Gast pressure/vacuum relief valve, AG258 will limit the operating duty by admitting or relieving air. It also allows full flow through the blower when the relief valve closes.

**SERVICING**

**⚠ WARNING** To retain their sealed construction they should be serviced by Gast authorized service centers ONLY. These models are sealed at the factory for very low leakage.

**⚠ WARNING** Turn off electric power before removing blower from service. Be sure rotating parts have stopped. Electric shock or severe cuts can result.

Inlet and exhaust filters attached to the blower may need cleaning or replacement of the elements. Failure to do so will result in more pressure drop, reduced air flow and hotter operation of the blower. The outside of the unit requires cleaning of dust and dirt. The inside of the blower also may need cleaning to remove foreign material coating the impeller and housing. This should be done at a Gast Authorized Service Center. This buildup can cause vibration, failure of the motor to operate or reduced flow.

**Motor Wiring Diagram for R4110N-50 & R3105N-50**

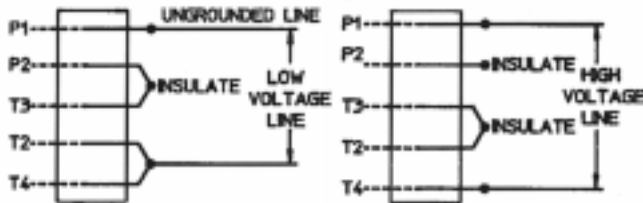

>>\* **WARNING**  
This motor is thermally protected and will automatically restart when protector resets. Always disconnect power supply before servicing.

**Motor Wiring Diagram for R4310P-50**

To reverse rotation, interchange the external connections to any two leads.

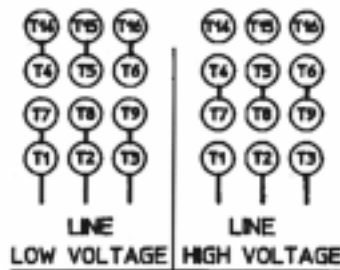

>>\* **WARNING**  
This motor is thermally protected and will automatically restart when protector resets. Always disconnect power supply before servicing.

**Motor Wiring Diagram for R5325R-50, R6340R-50, R6P355R-50 & R7100R-50**

To reverse rotation, interchange the external connections to any two leads.

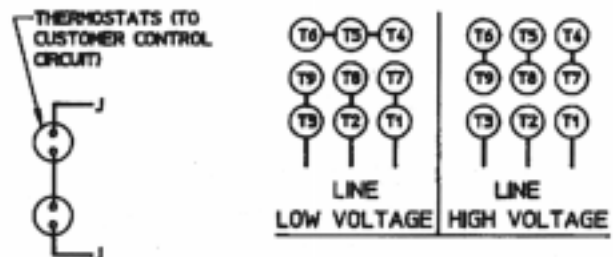

### Motor Wiring Diaphragm for R5125Q-50 & R4P115N-50

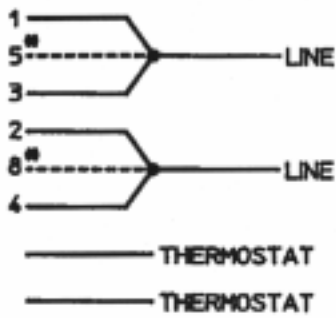

**LOW VOLTAGE**

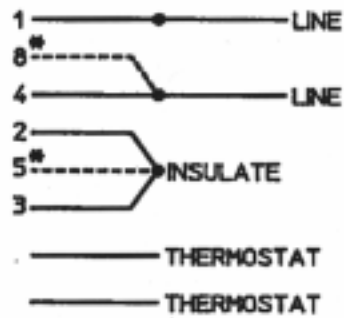

**HIGH VOLTAGE**

\*R5125Q-50 Blowers produced after September 1992 (Serial No. 0992) do not have motor leads 5 & 8.

### Motor Wiring Diaphragm for R6130Q-50 & R6P155Q-50

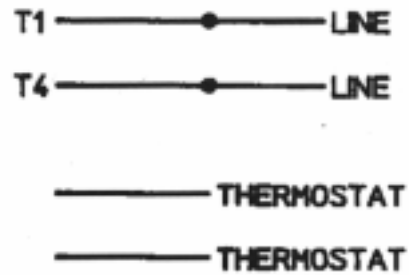

Connect Thermostat to Motor Protection Circuit

### Connection for Thermostat Motor Protection

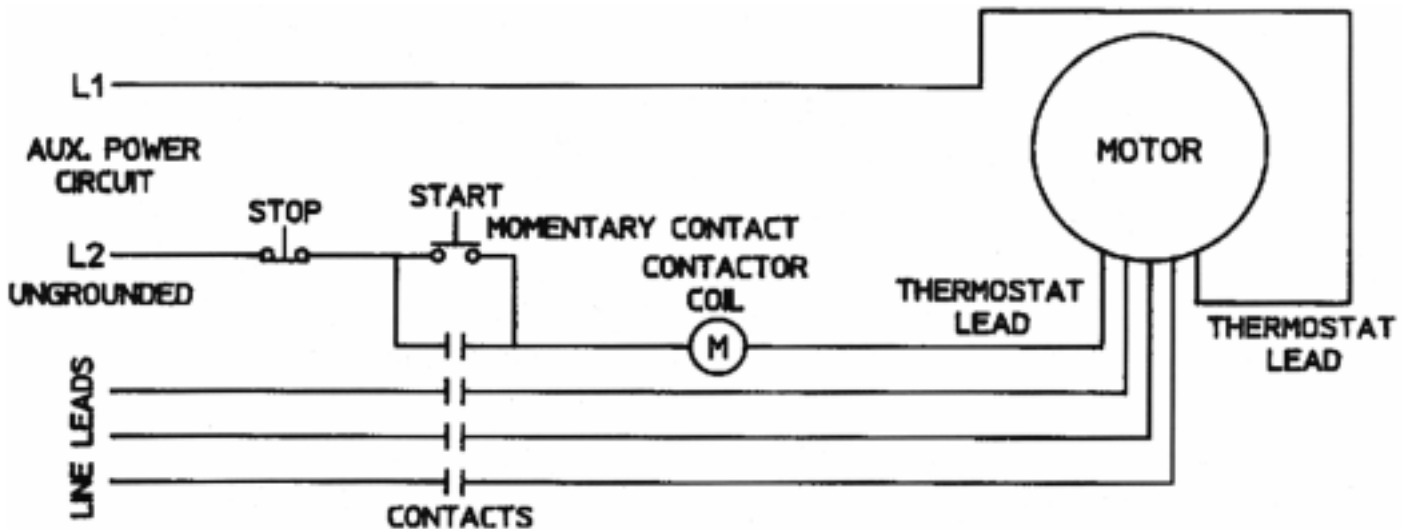

Thermostats to be connected in series with control as shown. Motor furnished with automatic thermostats rated A.C. 115-600V. 720VA circuit shown is for 3 phase motor. Single phase motor has two line leads in the above circuit.