





PRODUCT SPECIFICATION

**GAST**

A UNIT OF **LGX** CORPORATION  
BENTON HARBOR, MI U.S.A.

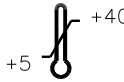
				
2100	<70 dB(A)	+5 °C	20% - 80%	12.75 LBS. 5.80 kG.
V	HP	kW	Hz	A
12 DC	1/8	0.09	---	14

PART NUMBER	REV.
RTD523	A
MODEL NO.	DOA-V502-JH

NOTES:



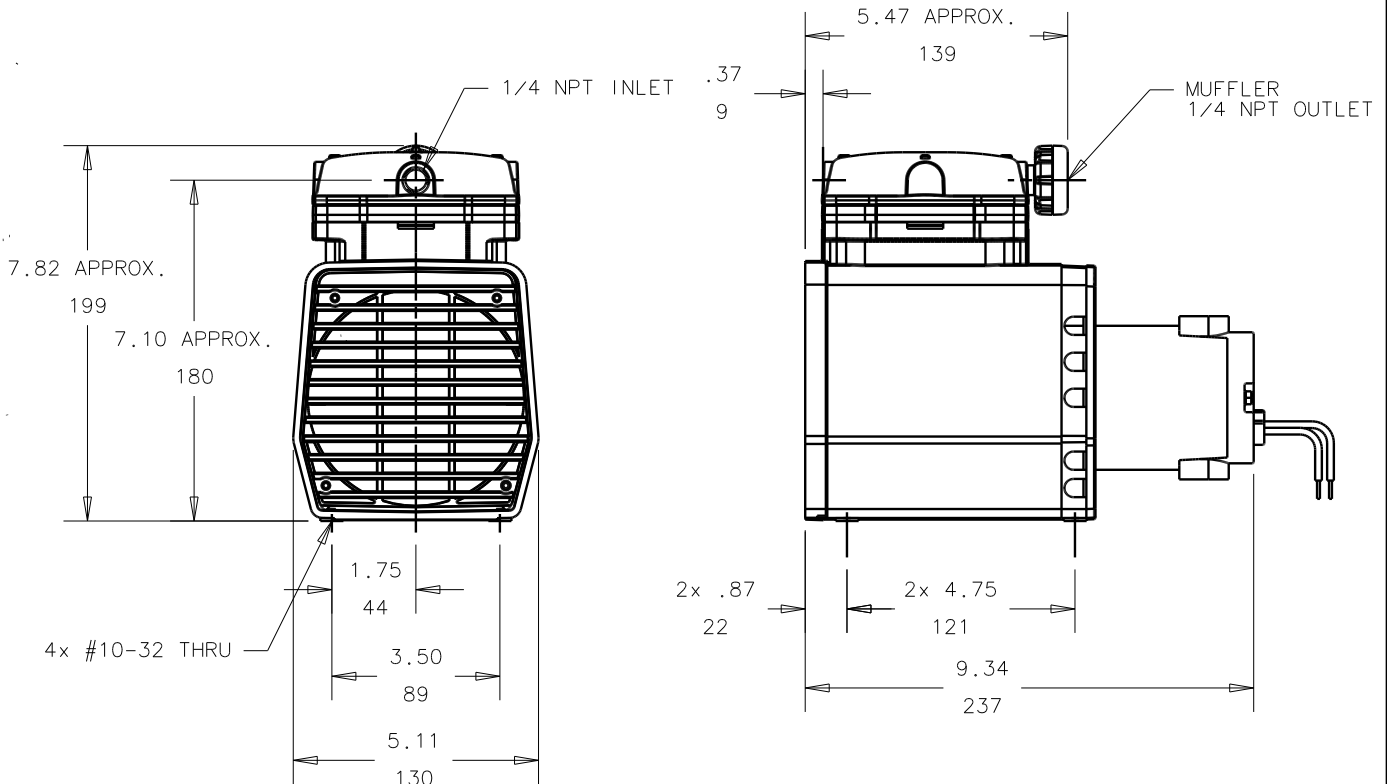
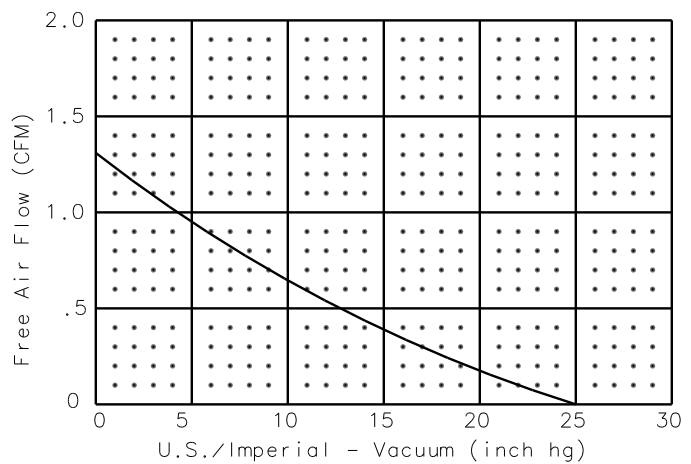
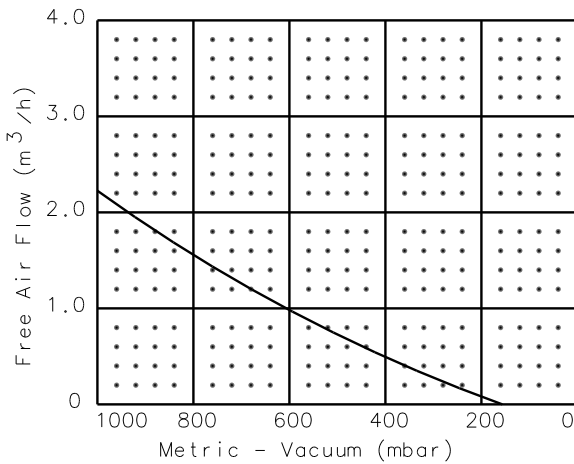

1. ALL DIMENSIONS ARE FOR REF. USE ONLY.
2. PRODUCT DIMENSIONS: U.S. IMPERIAL (inches), METRIC (mm).
3. TECHNICAL DATA SUBJECT TO CHANGE WITHOUT NOTICE.
4. ENVIRONMENT: CLEAN DUST FREE.
5. THIS MODEL REQUIRES ADDITIONAL CAPACITANCE TO BE APPLIED TO THE ELECTRICAL INPUT IN ORDER TO COMPLY WITH THE EMC DIRECTIVE. SEE SHEET 2 OF 2.



PRODUCT SPECIFICATION

**GAST**

A UNIT OF **LGX** CORPORATION  
BENTON HARBOR, MI U.S.A.

		 +40		
2100	<70 dB(A)	°C	20% - 80%	12.75 LBS. 5.80 kG.
V	HP	kW	Hz	A
12 DC	1/8	0.09	---	14

PART NUMBER	REV.
RTD523	A
MODEL NO.	DOA-V502-JH

DOA-V502-JH = 2x 0.47 mfd

JH x 1  
0.47 mfd

MOTOR CASE

JH x 1  
0.47 mfd

