



GAST MANUFACTURING, INC.
 A Unit of IDEX Corporation
 Post Office Box 97
 Benton Harbor, Michigan
 Ph: 269/926-6171
 Fax: 269/925-8288

PART NUMBER:

LTD229

REV.:

A

NOTES:

1. TECHNICAL DATA SUBJECT TO CHANGE WITHOUT NOTICE.
2. CONFORMS TO EUROPEAN STANDARD EN13463-1
 NON-ELECTRICAL EQUIPMENT FOR EXPLOSIVE
 ATMOSPHERES GROUP 11 CAT 2 (GAS & DUST),
 PROTECTED BY CONSTRUCTION (SURFACE TEMP. RATED 135C).

SOUND LEVEL 113 dB(A) MAX.
 NORMAL AMBIENT +1 degC - +120 degC
 RELATIVE HUMIDITY 0% - 100%
 ENVIRONMENT HAZARDOUS AMBIENT COMBUSTIBLE
GAS AND DUST +0°C TO +40°C

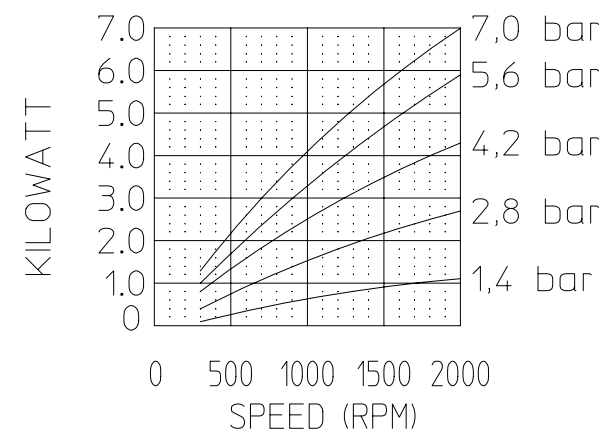
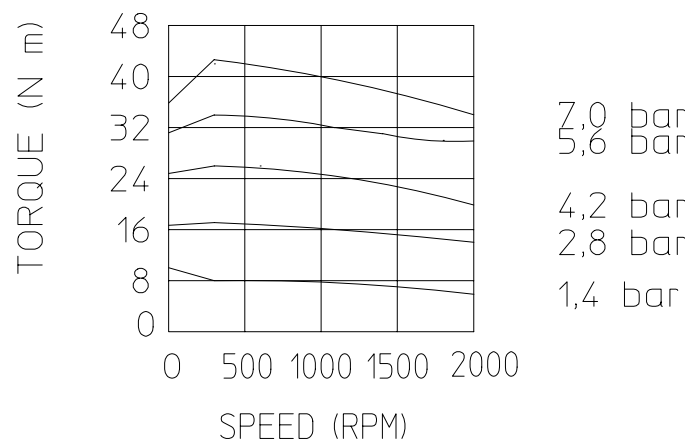
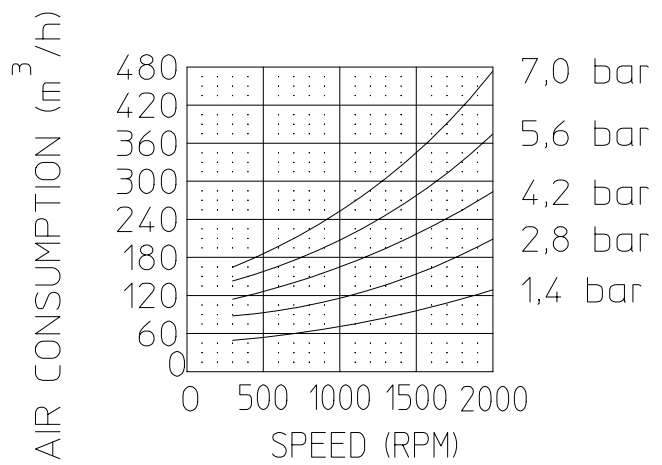
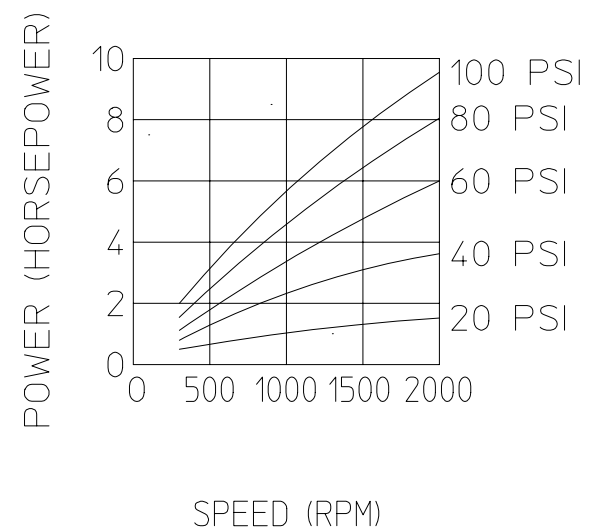
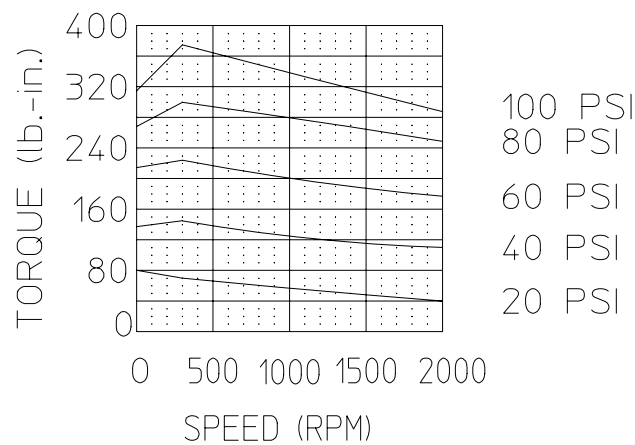
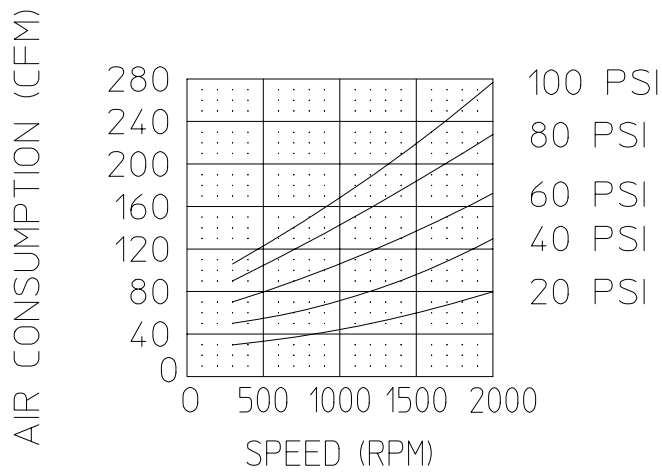
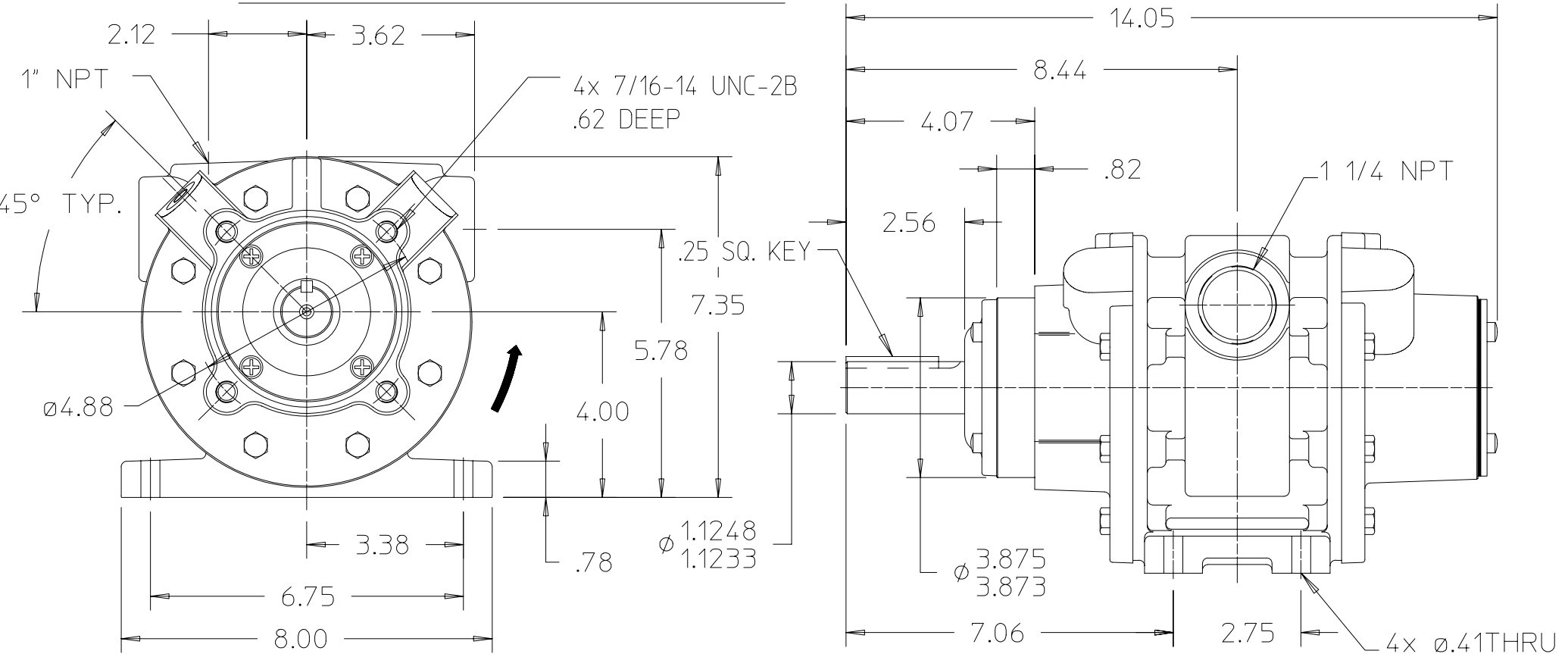

Product Specifications

| Model Number | MAX. PRESS. | | MAX. SPEED | HP | kW | Net Wt. | |
|--------------|-------------|-----|------------|-----|------|---------|------|
| | bar. | PSI | | | | lbs. | kg |
| 16AM-FCC-1 | 7,0 | 100 | 2,000 | 9.0 | 6,73 | 73 | 33.1 |